

RB 500™ 3" Fascia Blockout System - R28 Wirefree RTS Motor

Diagram

SPECIFICATIONS

Mount: **Ceiling, Wall, or End Mount**

Tube: **37mm (1.5")**

Shade Width: **19" - 80"**

Light Gap: **Motor End — 3/4" (.75")**

Idle End — 3/4" (.75")

Motor connection: **External Li-Ion Rechargeable Battery Pack**

Power connector: **10" Motor Charging Cable Plug**

Bracket Color: **Grey**

Bracket Cover Colors: **Black, Grey, & White**

Control Options: **Wireless Wall Switch,**

Wireless Remote, Universal Interface, Timer, Sun Sensor, mylink™ RTS Smartphone, Tablet, and Amazon Alexa Interface

Bracket	Dimensions	Max Roll Up
3" Fascia	3" H x 1" W x 3" D	2-3/4" (2.75")

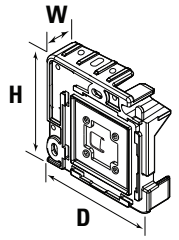

FASCIA COLORS



External Li-Ion Rechargeable Battery Pack
9.8125" x 1" x 0.9"

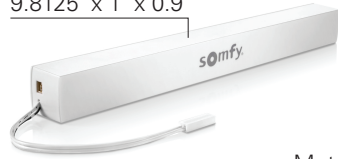

10" Motor Charging Cable
Motor Antenna

Cross Plate Adapter

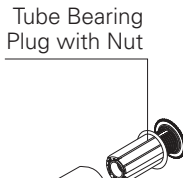

37mm Tube

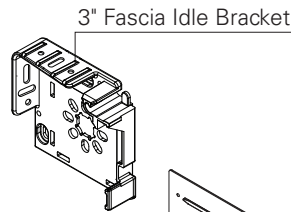

3" Fascia Idle Bracket

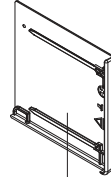

Bracket Cover

3" Fascia Motor Bracket

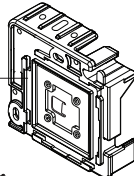

R28 WireFree RTS Motor

Bracket Cover

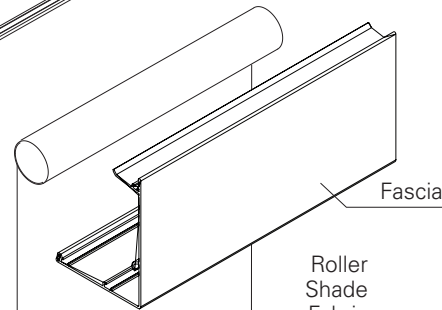
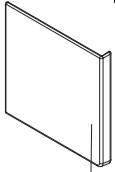

Fascia

Roller Shade Fabric



Side Channel with Wool Pile

Side Channel with Wool Pile

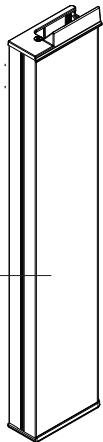

RB 500 Bottom Bar with Wool Pile

OPTIONS

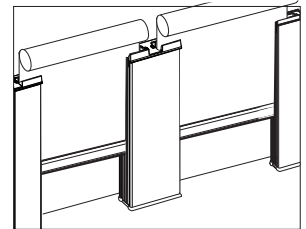

Middle Channel

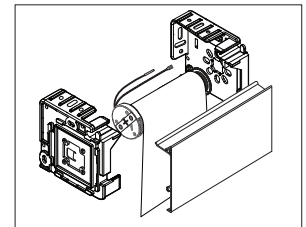

Reverse Roll Fascia

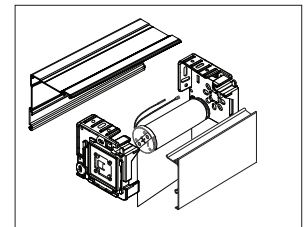

Back Fascia

Plug-In Charger

